

SHIMANO STEPS

Shimano Total Electric Power System

User's manual

E8000 Series

Original instructions

CONTENTS

IMPORTANT NOTICE	2
Important safety information	2
To ensure safety	2
Features of SHIMANO STEPS E8000 Series	5
Riding the bicycle	5
Assist mode	6
Names of parts.....	7
Specifications.....	8
Charging the battery.....	9
About the charger LED lamp.....	12
About the battery LED lamps.....	12
Handling and charging the battery.....	13
Installing / removing the battery	14
About the functions of the assist switches and shift switches	17
Installing and removing the cycle computer	18
Turning the power ON / OFF	19
Operating the cycle computer	20
Basic screen display	21
Changing assist mode	23
Switching to [WALK] mode (walk assist mode).....	24
Current gear and traveling data display.....	26
Switching between displayed traveling data	27
About the setting menus.....	29
Drive unit setting data backup function	47
Connection and communication with devices.....	47
About wireless functions.....	48
Troubleshooting	49
Battery LED lamp error indications	49
Error messages on the cycle computer	50
Troubleshooting	52



User's manuals in other languages are available at :

<http://si.shimano.com>

IMPORTANT NOTICE

- Contact the place of purchase or a bicycle dealer for information on installation and adjustment of the products which are not found in the user's manual. A dealer's manual for professional and experienced bicycle mechanics is available on our website (<http://si.shimano.com>).
- Do not disassemble or alter this product.
- Use the product according to local laws and regulations.
- The Bluetooth® word mark and logos are registered trademarks owned by the Bluetooth SIG, Inc. and any use of such marks by SHIMANO INC. is under license. Other trademarks and trade names are those of their respective owners.

For safety, be sure to read this user's manual thoroughly before use, and follow them for correct use.

Important safety information

For replacement information, contact the place of purchase or a bicycle dealer.

Be sure to observe the following in order to avoid burns or other injury from fluid leakages, overheating, fire or explosions.

To ensure safety



Handling the battery

- Do not deform, modify, disassemble or apply solder directly to the battery. Doing so may cause leakage, overheating, bursting, or ignition of the battery.
- Do not leave the battery near sources of heat such as heaters. Do not heat the battery or throw it into a fire. Doing so may cause bursting or ignition of the battery.
- Do not subject the battery to strong shocks or throw it. If this is not observed, overheating, bursting, or fire may occur.
- Do not place the battery into fresh water or sea water, and do not allow the battery terminals to get wet. Doing so may cause overheating, bursting, or ignition of the battery.

- Use the Shimano specified charger and observe the specified charging conditions when charging the specified battery. Not doing so may cause overheating, bursting, or ignition of the battery.



To ensure safe riding

- Do not give too much of your attention to the cycle computer display while riding, otherwise accidents may result.
- Check that the wheels are securely installed to the bicycle before commencing riding. If the wheels are not securely installed, the bicycle may fall over and serious injury may result.
- If riding a power-assisted bicycle, make sure that you are fully familiar with the starting-off characteristics of the bicycle before riding it on roads with several vehicle lanes and pedestrian footpaths. If the bicycle starts off suddenly, accidents may result.
- Check that the bicycle lights illuminate before riding at night.

Using the product safely

- Be sure to remove the battery and charging cable before wiring or attaching parts to the bicycle. Otherwise, an electric shock may result.
- When charging the battery while it is installed on the bicycle, do not move the bicycle. The power plug for the battery charger may come loose and not be fully inserted into the electrical outlet, resulting in risk of fire.
- When installing this product, be sure to follow the instructions given in the user's manual. Furthermore, it is recommended that you use only genuine Shimano parts at these times. If bolts and nuts are left loosened or the product is damaged, the bicycle may suddenly fall over and serious injury may result.
- Do not disassemble the product. Disassembling it may cause injury to persons.
- After reading the user's manual carefully, keep it in a safe place for later reference.

Handling the battery

- If any liquid leaking from the battery gets into your eyes, immediately wash the affected area thoroughly with clean water such as tap water without rubbing your eyes, and seek medical advice immediately. If this is not done, the battery liquid may damage your eyes.
- Do not recharge the battery in places with high humidity or outdoors. Doing so may result in electric shock.
- Do not insert or remove the plug while it is wet. If this is not observed, electric shocks may result. If there is water leaking out of the plug, dry it thoroughly before inserting it.
- If the battery does not become fully charged after 6 hours of charging, immediately unplug the battery from the outlet to stop charging, and contact the place of purchase. Doing so may cause overheating, bursting, or ignition of the battery.
- Do not use the battery if it has any noticeable scratches or other external damage. Doing so may cause bursting, overheating or problems with operation.
- The operating temperature ranges for the battery are given below. Do not use the battery in temperatures outside these ranges. If the battery is used or stored in temperatures outside these ranges, fire, injury or problems with operation may occur.
 1. During discharge: -10 °C - 50 °C
 2. During charging: 0 °C - 40 °C

Cleaning

- The frequency of maintenance will vary depending on the riding conditions. Periodically clean the chain using an appropriate chain cleaner. Do not use alkaline or acidic cleaning agents for removing rust under any circumstances. If such cleaning agents are used, they may damage the chain and serious injury may result.



To ensure safe riding

- Observe the instructions in the user's manual for the bicycle, in order to ride safely.

Using the product safely

- Periodically check the battery charger and adapter, particularly the cord, plug, and case, for any damage. If the charger or adapter is broken, do not use it until it has been repaired.
- This appliance is not intended for use by persons (including children) with reduced physical, sensory or mental capabilities, or lack of experience and knowledge, unless they have been given supervision or instruction concerning use of the appliance by a person responsible for their safety.
- Do not allow children to play near the product.

Handling the battery

- Do not leave the battery in a place exposed to direct sunlight, inside a vehicle on a hot day, or other hot places. This may result in battery leakage.
- If any leaked fluid gets on your skin or clothes, wash it off immediately with clean water. The leaked fluid may damage your skin.
- Store the battery in a safe place out of the reach of infants and pets.

Cleaning

- If any malfunctions or other problems occur, contact the place of purchase.
- Never attempt to modify the system yourself, as it may cause problems with system operation.

NOTE

Using the product safely

- Be sure to install caps to any connectors which are not being used.
- For installation and adjustment of the product, consult a dealer.
- The Product is designed to be fully waterproof to withstand wet weather riding conditions. However, do not deliberately place them into water.
- Do not clean the bicycle in a high-pressure wash. If water gets into any of the components, operating problems or rusting may result.
- Do not turn the bicycle upside down. The cycle computer or the shifting switch may get damaged.
- Handle the product carefully, and avoid subjecting it to any strong shocks.
- Although the bicycle still functions as a normal bicycle even when the battery is removed, the light does not turn on if it is connected to the electric power system. Be aware that using the bicycle under these conditions will be considered non-observance of the road traffic laws in Germany.
- When charging the battery while it is mounted on the bicycle, be careful of the following:
 - When charging, make sure there is no water on the charging port or the charger plug.
 - Ensure that the battery is locked into the battery mount before charging.
 - Do not remove the battery from the battery mount while charging.
 - Do not ride with the charger mounted.
 - Close the charging port cap when not charging.

Handling the battery

- When you carry a power-assisted bicycle in a car, remove the battery from the bicycle and place the bicycle on a stable surface in the car.
- Before connecting the battery, make sure that there is no buildup of water or dirt in the connector where the battery will be connected.
- The use of a genuine Shimano battery is recommended. If using a battery from another manufacturer, make sure to carefully read the instruction manual for the battery before use.

Disposal information for countries outside the European Union



This symbol is only valid within the European Union. Follow local regulations when disposing of used batteries. If you are not sure, consult the place of purchase or a bicycle dealer.

Connection and communication with PC

A PC linkage device can be used to connect a PC to the bicycle (system or components), and E-TUBE PROJECT can be used to carry out tasks such as customizing single components or the whole system and updating firmware.

- PC linkage device: SM-PCE1
- E-TUBE PROJECT: PC application
- Firmware: software inside each component

Connection and communication with smartphone or tablet

It is possible to customize single components or the system, and update firmware, using E-TUBE PROJECT for smartphones/tablets after connecting the bicycle (system or components) to a smartphone or tablet via Bluetooth LE.

- E-TUBE PROJECT: app for smartphones/tablets
- Firmware: software inside each component

Cleaning

- The number found on the battery mount key is necessary when purchasing spare keys. Keep it in a safe place. There is a space to enter the key number on the back cover of this user's manual. Enter the key number for safekeeping and later reference.
- Contact the place of purchase for updates of the product software. The most up-to-date information is available on the Shimano website. For details, refer to the "Connection and communication with devices." section.
- Do not use thinner or other solvents to clean any of the products. As such substances may damage the surfaces.
- You should periodically wash the chainrings in a neutral detergent. In addition, cleaning the chain with neutral detergent and lubricating it can be an effective way of extending the useful life of the chainrings and the chain.
- Use a damp cloth, with the water well wrung out, when cleaning the battery and plastic cover.
- For any questions regarding handling and maintenance, contact the place of purchase.
- Products are not guaranteed against natural wear and deterioration from normal use and aging.
- For maximum performance we highly recommend Shimano lubricants and maintenance products.

Assist

- If the settings are not correct, for instance if the chain tension is too tight, the proper assist force may not be obtained. If this happens, contact the place of purchase.

Label

- Some of the important information contained in this user's manual is also indicated on the battery charger label.

Features of SHIMANO STEPS E8000 Series

- Hi-End MTB assistance components.
- Powerful propulsion and silent drive unit.
- Smooth and natural power assistance and riding experience.
- Support optimal suspension design afforded by compact drive unit construction. Shorter chain stay frame gives rider easier handling.
- Assist power stopped simultaneously with the stop of the rider's pedaling. Quickly re-start assistance upon pedaling again. Power assist system cooperates and harmonizes with human output.
- Superior control performance facilitates comfortable riding on mountain trails.
- Efficient pedaling even when power assist cuts off.
- Easy to operate assist switch system designed in accordance with ergonomic principles.
- Cycle computer that is compact without loss in visual clarity provides detailed traveling data by color recognition.
- Q-Factor comparable to mountain bikes reduces burden on the legs from the MTB rider's experiences.
- Optional chain device supports for rough riding conditions available.
- Large-capacity battery allows you to enjoy long rides.
- Intelligent [WALK] assist with SEIS RD provides powerful assistance when walking the bicycle across uneven terrain such as rocky areas.

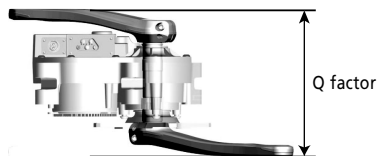

■ Riding the bicycle

1. Turn on the power.

- Do not place your feet on the pedals when turning the power on. A system error may result.
- Power cannot be turned on while charging.

2. Select your preferred assist mode.

3. Assistance will start when the pedals start turning.



4. Change the assist mode in accordance with the riding conditions.

5. Turn the power off when parking the bicycle.

- Do not place your feet on the pedals when turning the power off. A system error may result.

■ Assist mode

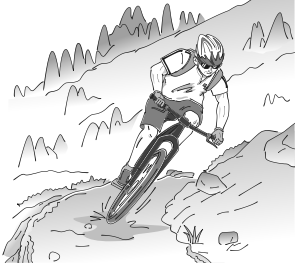
You can select an assist mode for each particular application.

BOOST	TRAIL	ECO
		
<p>Use when powerful assistance is required, such as when riding up steep uphill slopes. This mode is designed for use on steep inclines and precipitous mountains. When riding on level public roads with traffic lights, the assistance provided may be excessive, in which case, switch to [ECO] mode.</p>	<p>Use when an intermediate level of assistance is needed, such as when you want to enjoy riding comfortably on a gentle slope or level ground.</p>	<p>Use when you want to enjoy long distance riding on level ground. When pedaling is not very strong, the amount of assistance is reduced and energy consumption is lessened.</p>
<p>When the battery level is running low, the level of assistance is lowered to increase the traveling range.</p>		
<p style="text-align: center;">OFF</p>		
<p>This mode does not provide power assistance when the power is turned on. Since there is no power consumption associated with the power assistance, it is useful for reducing battery consumption when the battery is running low.</p>		
<p style="text-align: center;">WALK</p>		
<p>This mode is particularly useful when walking the bicycle, taking the bicycle out up an incline or when it is bearing a heavy load. It is also useful when walking the bicycle across uneven terrain such as rocky areas.</p> <p>The intelligent walk assist function activates when an electric shifting system such as XTR, DEORE XT SEIS is connected. System individually supplies assist power to detect gear position.</p> <p>"Intelligent walk assist" support rider more torque output in steep climb condition in lower side gears.</p> <p>"Quick walk assist" function works quickly by holding down SW from any mode.</p>		

Names of parts

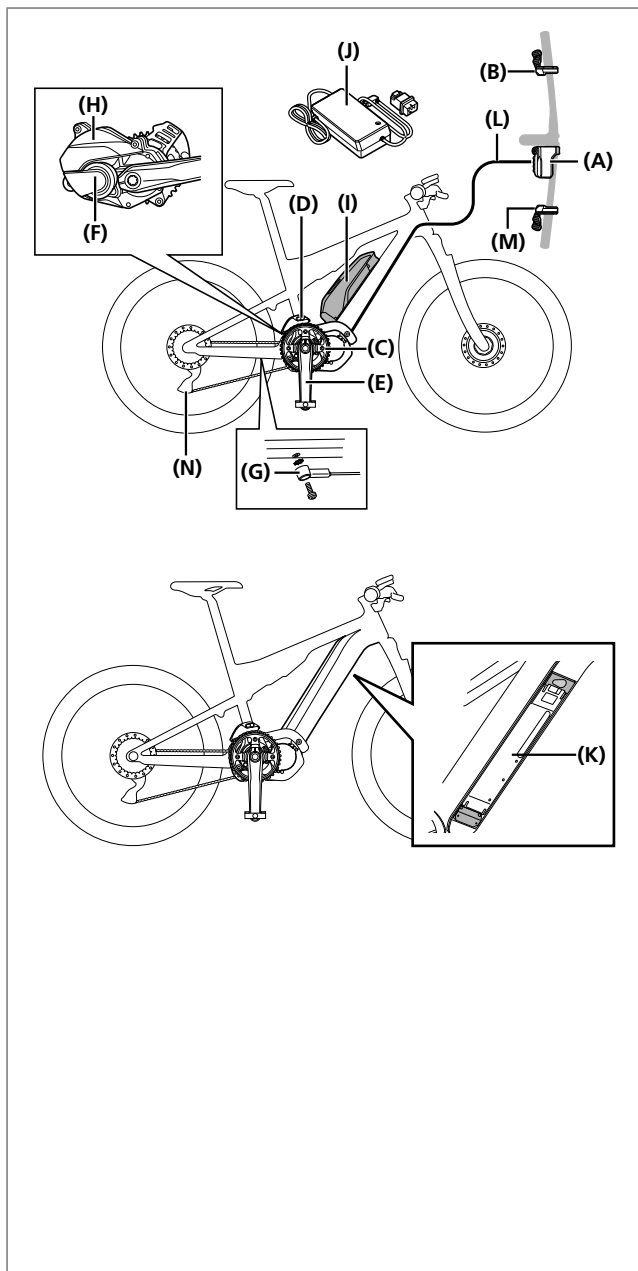

- (A)** Cycle computer:
SC-E8000
SC-E6010
- (B)** Assist switch:
SW-E8000-L
SW-E6000
- (C)** Front chainring:
SM-CRE80
SM-CRE80-B
- (D)** Chain device:
SM-CDE80
- (E)** Crank arm:
FC-E8000
FC-E8050
- (F)** Drive unit:
DU-E8000
- (G)** Speed sensor:
SM-DUE10
- (H)** Drive unit cover:
SM-DUE80-A/SM-DUE80-B
- (I)** Battery (external type)/
Battery mount (external type):
BT-E8010
BM-E8010
BT-E6010
BM-E6010
- (J)** Battery charger:
EC-E6000
- (K)** Battery (built-in type)/
Battery mount (built-in type):
BT-E8020
BM-E8020
- (L)** E-TUBE(EW-SD50)
- When using electronic gear shifting**
- (M)** Shifting switch:
SW-M9050-R
SW-M8050-R
- (N)** Rear derailleur (DI2):
RD-M9050
RD-M8050

Specifications

Operating temperature range: During discharge	-10 – 50°C	Battery type	Lithium ion battery
Operating temperature range: During charging	0 – 40°C	Nominal capacity	Refer to the user's manual for the battery "UM-70F0A". For the latest information on manuals, see the website (http://si.shimano.com).
Storage temperature	-20 – 70°C	Rated voltage	36 V DC
Storage temperature (Battery)	-20 – 60°C	Drive unit type	Midship
Charging voltage	100 – 240 V AC	Motor type	Brush-less DC
Charging time	Refer to the user's manual for the battery "UM-70F0A". For the latest information on manuals, see the website (http://si.shimano.com).	Rated drive unit power	250 W

* The range of the assist function speed is different depending on the specifications.

DU-E8000: 25km/h or less

Charging the battery

You cannot use the battery immediately after shipment.

The battery can be used after charging it with the designated charger.

Be sure to charge it before use. The battery can be used when the LED on it lights up.

The use of a genuine Shimano battery is recommended. If using a battery from another manufacturer, make sure to carefully read the instruction manual for the battery before use.



DANGER

- Use the Shimano specified charger and observe the specified charging conditions when charging the specified battery. Not doing so may cause overheating, bursting, or ignition of the battery.



CAUTION

- When removing the battery charger power plug from the outlet or the charging plug from the battery, do not pull it out by the cord.
- When charging the battery while it is mounted on the bicycle, be careful not to trip over the charger cord or get anything caught on it. This may lead to injury or cause the bicycle to fall over, damaging the components.



- If the bicycle is stored for an extended period of time immediately after purchase, you will need to charge the battery before using the bicycle. Once the battery is charged, it starts to deteriorate.
- Connect to E-TUBE PROJECT and click [Connection check] to confirm whether the battery in use is a genuine Shimano battery or another brand.

When charging the battery alone

Battery charger: EC-E6000

Battery: BT-E8010/BT-E8020

1. Connect the battery charger's power plug to the outlet.
2. Insert the charging plug into the battery's charging port.
 - Charge the battery on a flat surface indoors.

BT-E8010

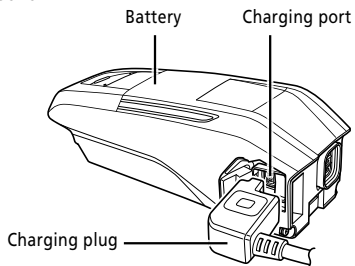

BT-E8020

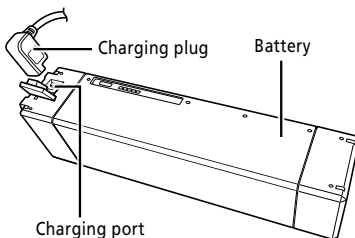

Battery charger: EC-E6000

Battery: BT-E6010

1. Attach the adapter to the charging plug.
2. Plug the charger's power plug into the outlet.
3. Plug the adapter into the battery's charging port.
 - When inserting the adapter into the charging port, insert it so that the charging plug is positioned below the adapter. The adapter cannot be inserted if the charging plug is above the adapter.
 - Charge the battery on a flat surface indoors.

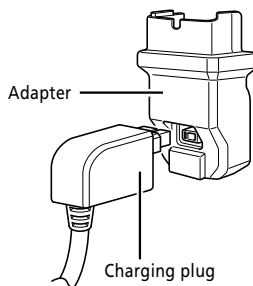

BT-E6010

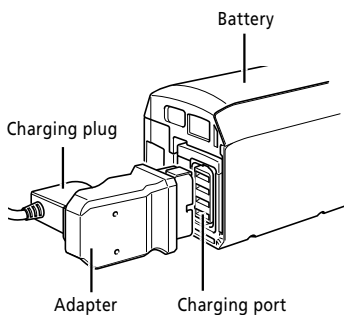

Charging the battery while installed onto the bicycle

Battery charger: EC-E6000

Battery: BT-E8010/BT-E8020/BT-E6010

1. Insert the battery charger power plug into the outlet.
2. Insert the charging plug into the charging port on the battery mount or the battery.
 - * Place the battery charger main body on a steady surface such as the floor before charging.
 - * Stabilize the bicycle to ensure that it does not collapse during charging.

BT-E8010

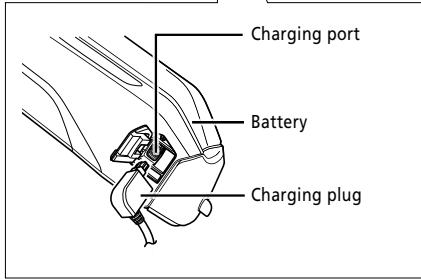
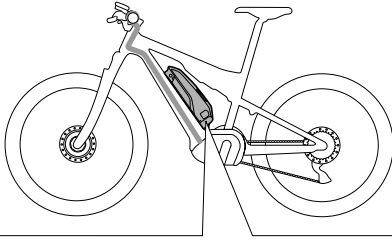

BT-E8020

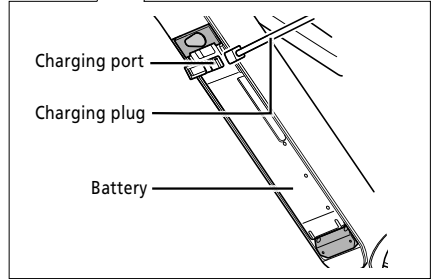
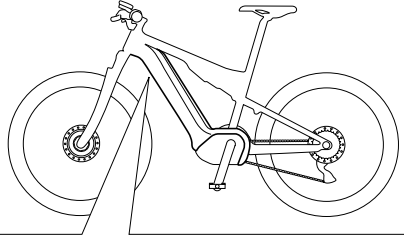

BT-E6010

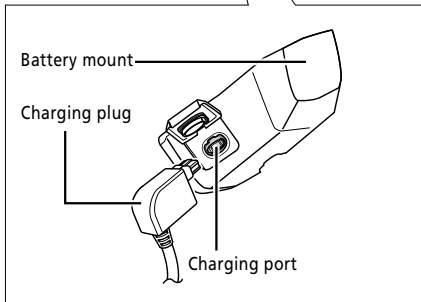
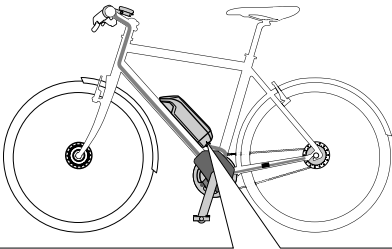

■ About the charger LED lamp

After charging has started, the LED lamp on the charger lights up.

○ Lit up	Charging (Within 1 hour after the completion of charging)
☼ Blinking	Charging error
● Turned off	Battery disconnected (1 hour or more after the completion of charging)

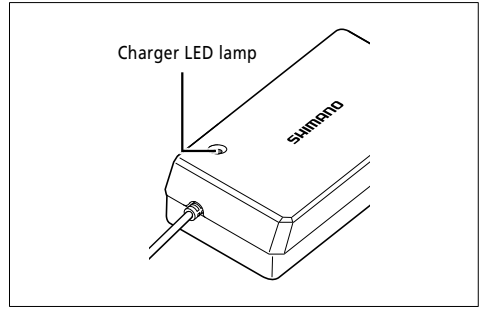

■ About the battery LED lamps

You can check the current charging status on the LED lamp on the battery.

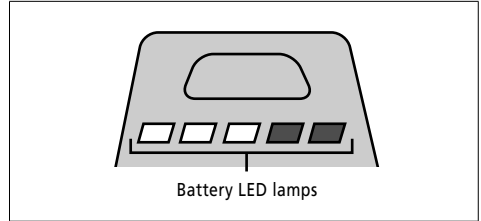







Charging-in-progress indication

Battery level indication*1	Battery level
	0% - 20%
	21% - 40%
	41% - 60%
	61% - 80%
	81% - 99%
	100%

*1 : No light : Lit up : Blinking

Battery level indication

The current battery level can be checked by pressing the battery's power button.

Battery level indication*1	Battery level
	100% - 81%
	80% - 61%
	60% - 41%
	40% - 21%
	20% - 1%
	0% (When battery is not installed on bicycle)
	0%, Power off / Shutdown (When battery is installed on bicycle)

*1  : No light  : Lit up  : Blinking

NOTE

When remaining battery capacity is low, system functions begin to shut off in the following order.

1. Power assistance (Assist mode automatically switches to [ECO] and then assistance shuts off)
2. Gear shifting
3. Light

■ Handling and charging the battery

Charging can be carried out at any time regardless of the amount of charge remaining, but you should fully charge the battery at the following times. Be sure to use the dedicated charger when recharging the battery at these times.

- The battery is not fully charged at the time of purchase. Before riding, be sure to charge the battery until it is fully charged.

If the battery has become fully spent, charge it as soon as possible. If you leave the battery without charging it, it will cause the battery to deteriorate.

- If the bicycle will not be ridden for a long period of time, store it away with approximately 70% battery capacity remaining. In addition, take care not to let the battery become completely empty by charging it every 6 months.

■ Installing / removing the battery

Installation of the battery

BT-E8010/BT-E6010

1. Align the indentation in the bottom of the battery with the protrusion on the holder and insert the battery.

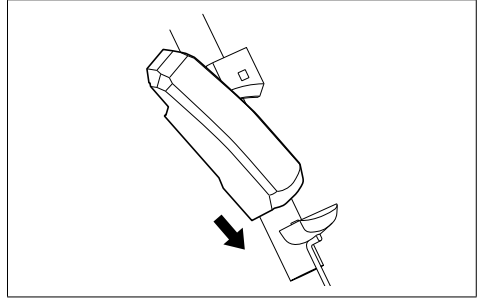

2. Slide the battery to the right starting from the point where it is inserted. Push in the battery until you hear it click.
3. Return the key to the locking position, remove it, and store it in a safe place.

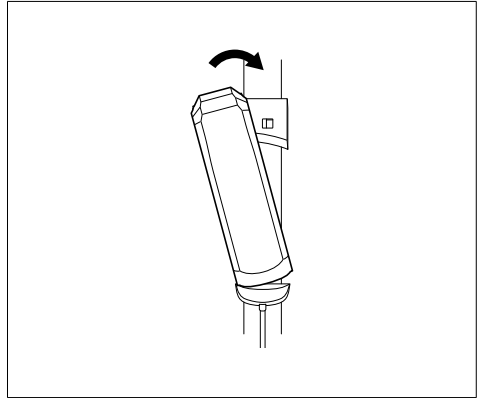

NOTE

- Check to see that the battery is locked before riding the bicycle. The battery may fall out while riding if not properly locked in place.
- Before riding, make sure that the charging port cap is closed.
- To prevent the battery from falling out, do not ride the bicycle with the key inserted.

BT-E8020

For the purposes of demonstration, these instructions take as an example a frame design where the battery is removed/installed from below.

Insert the battery into the battery mount until there is a click.

- When inserted until a click is heard, the battery is locked automatically.

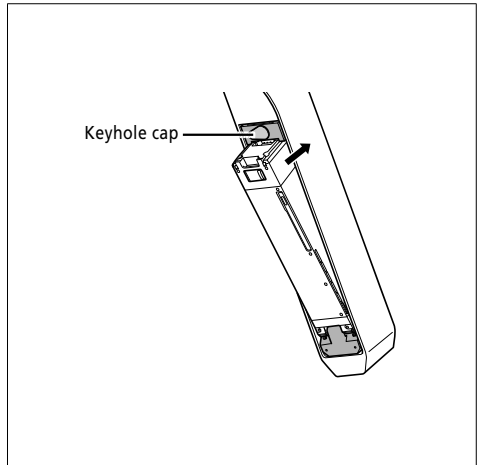

NOTE

- Check that the battery is locked before riding the bicycle. The battery may come loose and fall out if not properly locked in place before riding.
- Before riding, make sure that the keyhole cap and charging port cap are closed.
- To prevent the battery from falling out, do not ride the bicycle with the key inserted.

Removing the battery

The following description may not be applicable as different types of keys are available.

BT-E8010/BT-E6010

1. Turn off the power, then insert the key into the key cylinder in the battery holder.



- The position of the key does not affect the insertion of the battery. You can insert it regardless of the key position.
- You cannot remove the key when it is not in the inserting position.

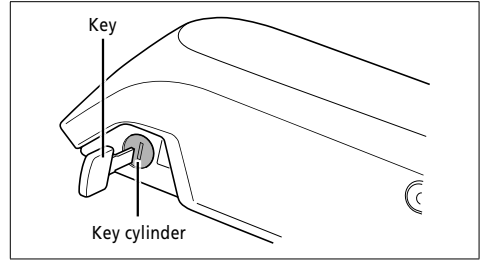

2. To unlock the battery turn the key to the left until you feel some resistance.

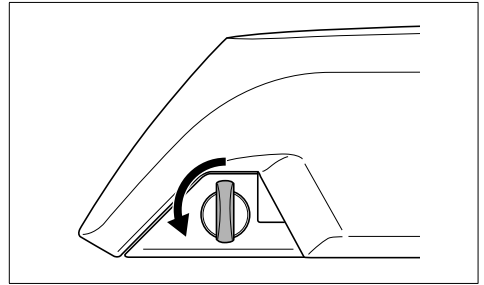

3. Hold the upper part of the battery and slide it to the left to remove it.

NOTE

Hold the battery firmly and be careful that it does not drop when removing or carrying it.

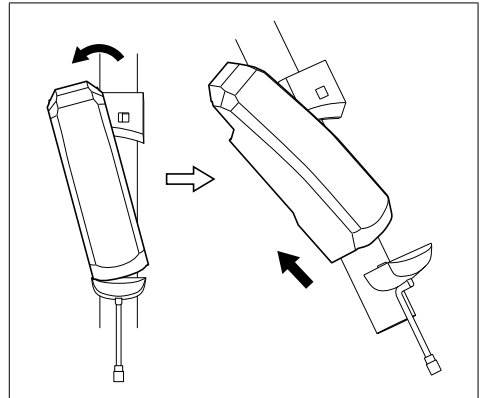

BT-E8020

- For the purposes of demonstration, these instructions take as an example a frame design where the battery is removed/ installed from below.
- If using a battery cover manufactured by another company, remove the battery cover before removing the battery.

1. Remove the keyhole cap.

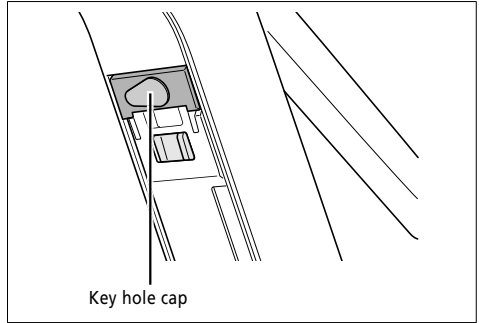

2. Insert the key into the key cylinder in the battery mount.



- The position of the key does not affect the insertion of the battery. You can insert it regardless of the key position.
- You cannot remove the key when it is not in the inserting position.

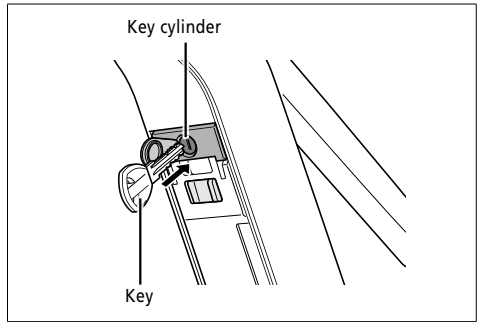

3. The battery detaches automatically when the key is turned clockwise and pushed in.

NOTE

Support the battery with your hand when detaching to make sure that it does not fall out.

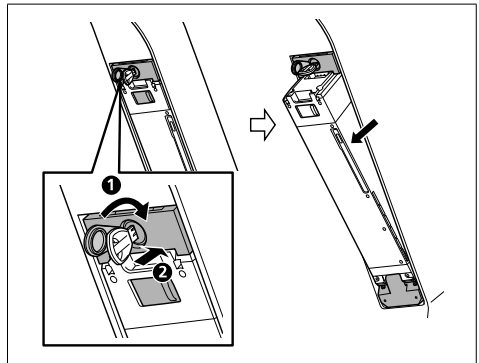

About the functions of the assist switches and shift switches

The operation procedure provided here refers to cases where the cycle computer is set to the default values.

SW-E8000-L/SC-E8000/SW-M8050-R (SW-M9050-R)

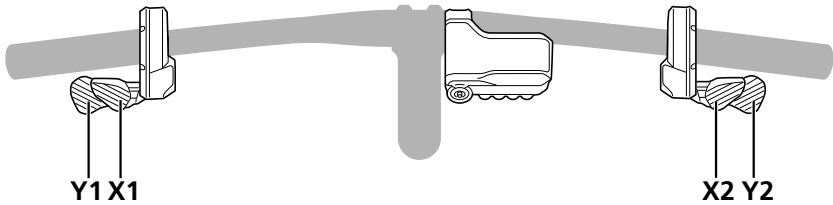

SW-E8000-L		SW-M8050-R (SW-M9050-R)	
X1	Switching assist modes: the level of assistance becomes stronger	X2	Shifting gears: pedaling becomes heavier
Y1	Switching assist modes: the level of assistance becomes weaker	Y2	Shifting gears: pedaling becomes lighter

SC-E6010/SW-E6000

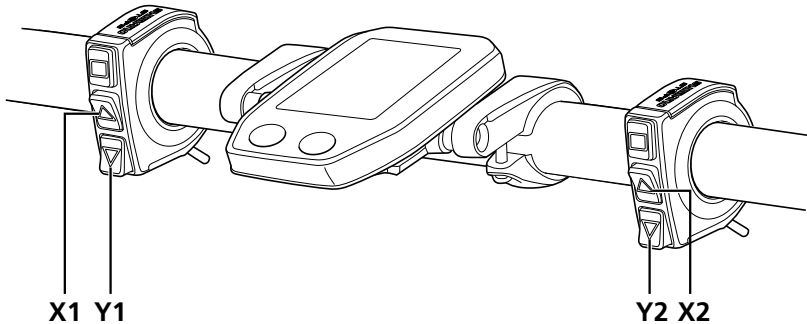

X1	When switching assist modes: the level of assistance becomes stronger When shifting gears: pedaling becomes heavier	X2	When switching assist modes: the level of assistance becomes stronger When shifting gears: pedaling becomes heavier
Y1	When switching assist modes: the level of assistance becomes weaker When shifting gears: pedaling becomes lighter	Y2	When switching assist modes: the level of assistance becomes weaker When shifting gears: pedaling becomes lighter

■ Installing and removing the cycle computer

SC-E6010

Slide the cycle computer onto the bracket as shown in the illustration to install it.

Insert the cycle computer securely until it clicks into place.

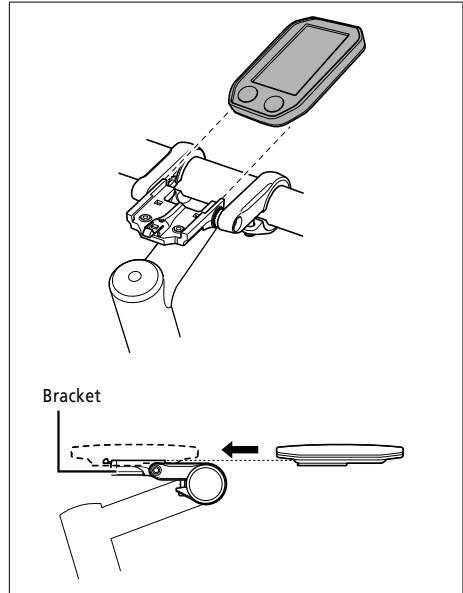

To remove the cycle computer, push the lever of the bracket firmly while sliding out the cycle computer.



If the cycle computer is not correctly in place, the assist function will not operate normally.

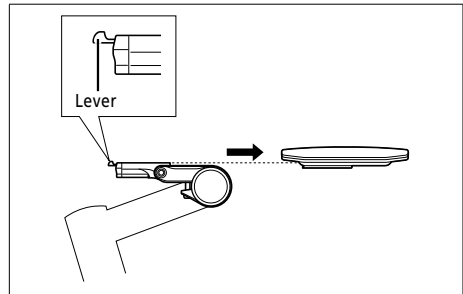

For details on installing SC-E8000, consult the place of purchase or a bicycle dealer.

■ Turning the power ON / OFF

Automatic power off function

If the bicycle has not moved for over 10 minutes, the power will automatically turn off.

Turning the power ON and OFF via the battery

BT-E8010/BT-E8020/BT-E6010

Press the power button on the battery. The LED lamps will light up indicating remaining battery capacity.

NOTE

- When turning on the power, check that the battery is firmly attached to the holder.
- Power cannot be turned on while charging.
- Do not place your foot on the pedals when turning on. A system error may result.



BT-E8010/BT-E8020 can be forced to power off by holding down the power button for 6 seconds.

BT-E8010

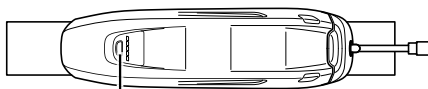

Power button

BT-E8020

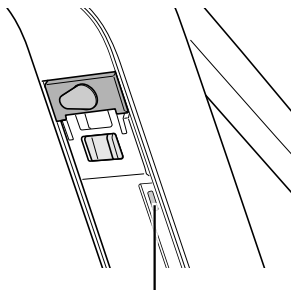

Power button

BT-E6010

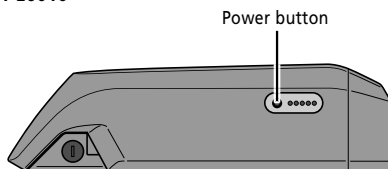

Power button

Turning the power ON and OFF via the cycle computer

SC-E6010

- Hold down the power button on the cycle computer for 2 seconds.

NOTE

If internal battery of cycle computer isn't charged sufficiently, the power will not turn on.
The internal battery will be charged if put on the bike after turning on.



Power button

SHIMANO STEPS logo screen

This screen is displayed during system start up and shutdown.



Operating the cycle computer

SW-E8000-L/SC-E8000

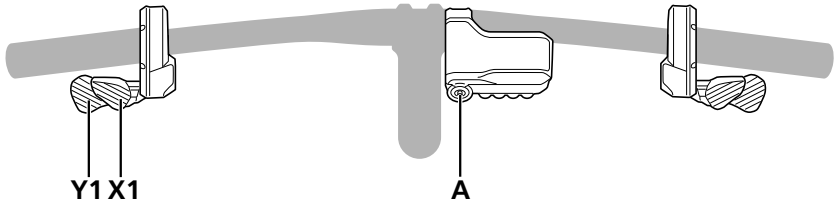

SC-E6010/SW-E6000

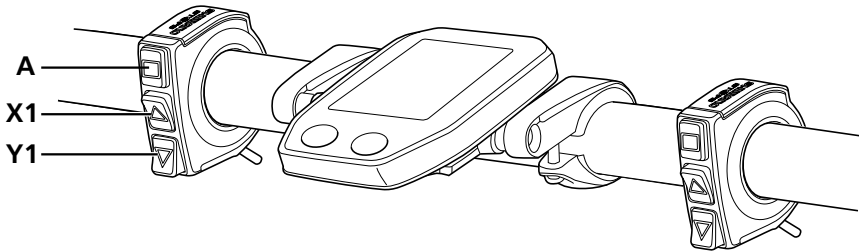

X1/Y1	Used for moving the setting menu cursor, adjusting settings, etc.
A	Used for switching between screens and confirming settings.

■ Basic screen display

Displays the status of the power assisted bicycle, traveling data.

- These explanations for the cycle computers SC-E8000 and SC-E6010, referred to in this instruction manual, are illustrated using the screen displays of SC-E8000 only, except where the displays of the cycle computers differ significantly.

(A) Battery level indicator

Displays the current battery level.

(B) Gear position (Only displays when electronic gear shifting is in use)

Displays the currently set gear position.

(C) Assist gauge

Displays the assistance.

(D) Assist mode display

Displays the current assist mode. ([ECO] mode automatically activates as remaining battery capacity declines.)

(E) Current speed

Displays the current speed.

The display can be switched between km/h and mph.

(F) Current time

Shows the current time.

(G) Icon to indicate when the light is on

Notifies you when the battery-powered light is on.

(H) Traveling data display

Displays the current traveling data.

SC-E8000

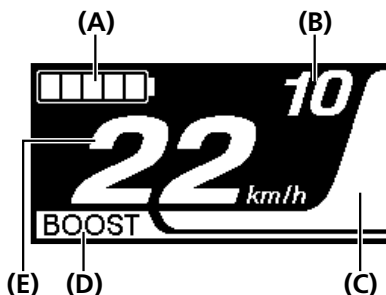



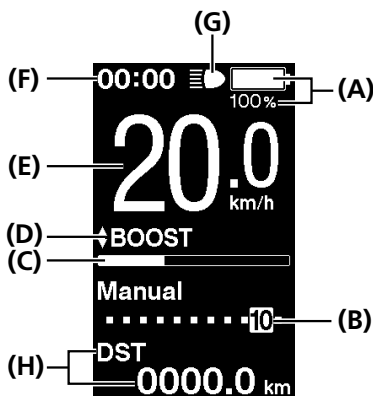



SC-E6010



Battery level indicator





You can check the battery level on the cycle computer while riding.

SC-E8000

Display	Battery level
	81 - 100%
	61 - 80%
	41 - 60%
	21 - 40%
	1 - 20%*
	0%

* The battery level indicator blinks red when remaining battery capacity falls to this level.

SC-E6010

Display	Battery level
	100%
	
	0%

■ Changing assist mode

Press X1 or Y1 to switch assist modes.

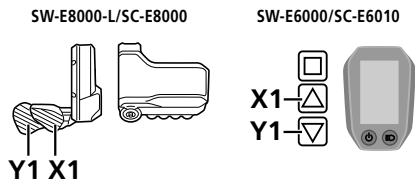

SC-E8000



SC-E6010



BOOST: Assist boost

TRAIL: Assist trail

ECO: Assist eco

OFF: Assist off

WALK: Walk assist

↑ : Short press X1

↓ : Short press Y1

.....▶ : Long press Y1

◀ : Short press X1 (This operation is for canceling [WALK] mode)

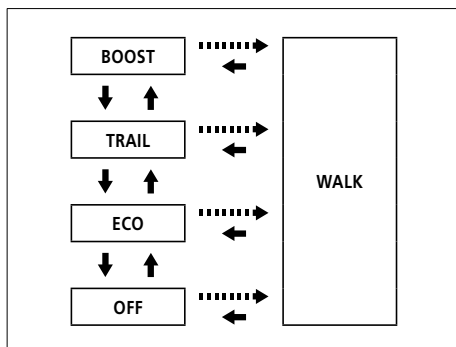

■ Switching to [WALK] mode (walk assist mode)

1. With your feet off the pedals and current speed at [0 km/h], hold down Y1 until [WALK] displays.

SW-E8000-L/SC-E8000

SW-E6000/SC-E6010

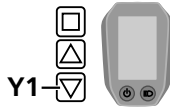
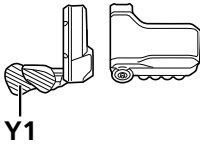

NOTE

A warning tone will sound while switching is in progress if it is not possible to switch to [WALK] mode because the current speed is not [0 km/h] or there is pressure on the pedals etc.

2. Release Y1 when [WALK] displays.

3. Hold down Y1 again to activate walk assist.

- Walk assist remains active provided Y1 is being held down.

SC-E8000



SC-E6010

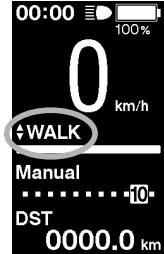
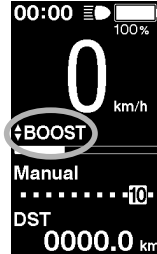

4. To cancel [WALK] mode, release Y1 and press X1.

- When [WALK] mode is canceled, the mode active before [WALK] mode was set, is re-activated.

SW-E8000-L/SC-E8000

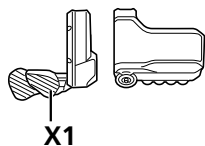

SW-E6000/SC-E6010

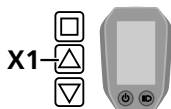

-
- If Y1 is not pressed for one minute or more, the mode active before [WALK] mode was set, is re-activated.
 - If the bicycle is not moved after [WALK] mode is activated, walk assist is automatically inactivated. To re-activate [WALK] mode, momentarily release Y1 and then hold down Y1.
 - The walk assist function can operate at a maximum of 6 km/h.
 - The assistance level and speed vary with the gear position.
 - The intelligent walk assist function activates when an electric shifting system such as XTR, DEORE XT SEIS is connected.

System individually supplies assist power to detect gear position.

"Intelligent walk assist" support rider more torque output in steep climb condition in lower side gears.

"Quick walk assist" function works quickly by holding down SW from any mode.

■ Current gear and traveling data display

(A) Gear position (Only displays when electronic gear shifting is in use)

(B) Traveling data display

SC-E8000

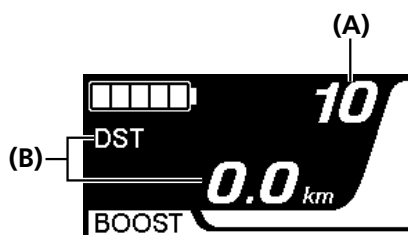

SC-E6010

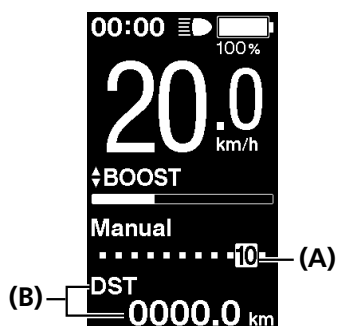

■ Switching between displayed traveling data

The type of traveling data displayed changes each time you press A.

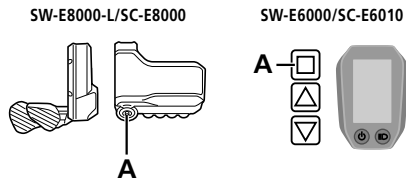

Holding down A when DST is displayed clears all traveling data.

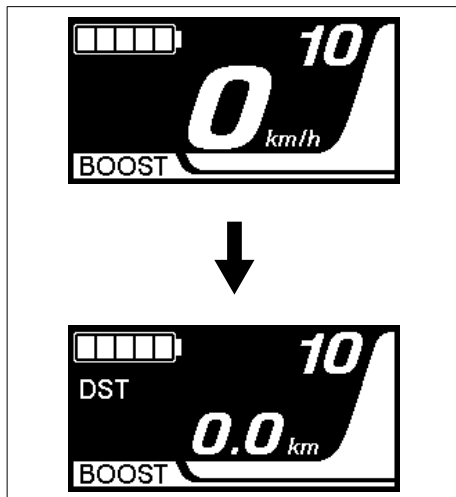

- (A) Traveling distance
- (B) Cumulative distance
- (C) Maximum traveling distance *1, 3
- (D) Traveling time (optional) *2
- (E) Average speed (optional) *2
- (F) Maximum speed (optional) *2
- (G) Number of crank rotations *2
- (H) Current time *4

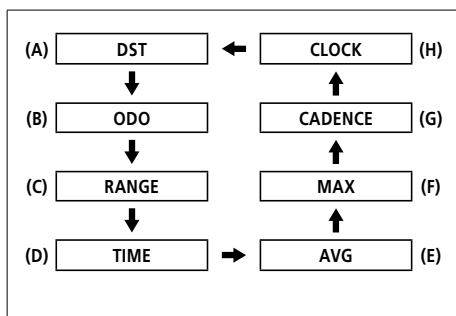

*1 When [RANGE] is displayed, the battery level is not displayed. The traveling range should be used as a reference only.

*2 Optional item: You can configure the display settings in E-TUBE PROJECT. For details, refer to the "Connection and communication with devices." section.

*3 When walk assistance is functioning, the on screen display [RANGE] changes to [RANGE ---].

*4 Displayed constantly on SC-E6010.

NOTE

When traveling data is displayed, the screen returns to speed display after 60 seconds.

When speed data is displayed, pressing A changes the traveling data displayed starting with DST.

Clearing the traveling distance

You can clear the traveling distance in the main screen.

1. Change the traveling data display to DST and press **A** for 2 seconds.
2. Release the finger when the DST indication starts blinking.
In this state, pressing **A** again clears the traveling distance.



-
- The DST indicator light stops blinking and the screen takes you back to the basic screen after leaving it alone for 5 seconds.
 - When the traveling distance is cleared, TIME, AVG and MAX are also cleared.
-

■ About the setting menus

Accessing the setting menu

SW-E8000-L/SC-E8000

1. Hold down A when the bicycle is not moving to display the menu list screen.

SW-E8000-L/SC-E8000

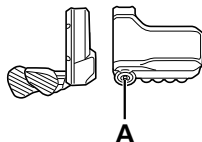

SW-E6000/SC-E6010

1. Hold down X1 and Y1 when the bicycle is not moving to display the menu list screen.

SW-E6000/SC-E6010

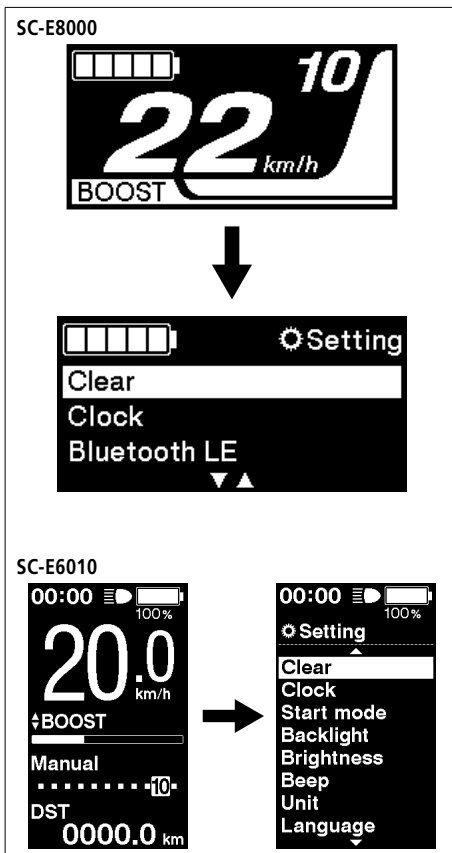
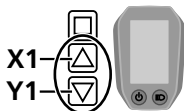

2. Press X1 or Y1 to select the various menus. Press A to display the setting screen for the selected menu.

SW-E8000-L/SC-E8000

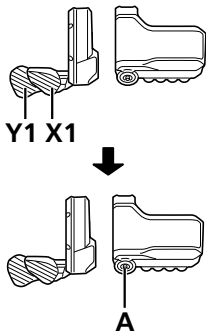

- (A) Clear settings
- (B) Clock setting
- (C) Bluetooth LE pairing
- (D) Bluetooth LE/ANT connection status
- (E) Turning the light on/off
- (F) Display backlight brightness setting
- (G) Turning the beep noise on/off
- (H) Switching between km and miles
- (I) Language setting
- (J) Adjusting the electronic gear shifting unit
- (K) Activating RD Protection Reset*
- (L) Return to the main screen

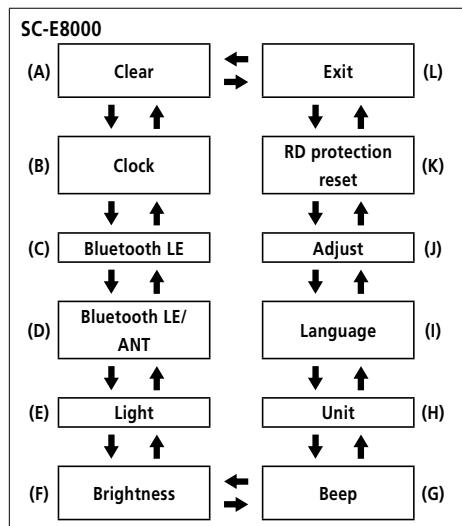

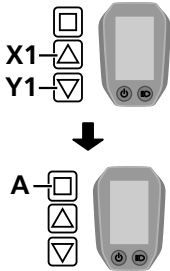

- (A)** Clear settings
- (B)** Clock setting
- (C)** Turning the display backlight on/off
- (D)** Display backlight brightness setting
- (E)** Turning the beep noise on/off
- (F)** Switching between km and miles
- (G)** Language setting
- (H)** Changing the font color
- (I)** Adjusting the electronic gear shifting unit
- (J)** Activating RD Protection Reset*
- (K)** Return to the main screen

[Start mode] and [Auto] are displayed on the menu list screen; however, they are not available for use.

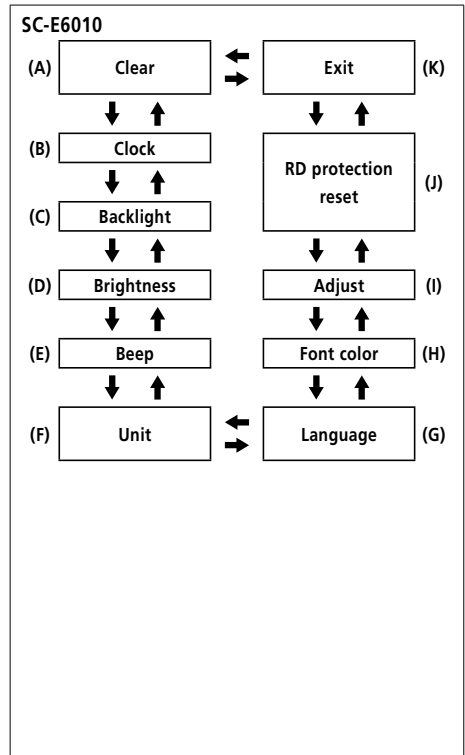

* In order to protect the system from falling down etc., if the bicycle is subjected to a strong impact, the RD Protection function will operate and the connection between the motor and the link will be momentarily severed so that the rear derailleur can no longer operate. Executing RD Protection Reset restores the connection between the motor and the link, as well as the function of the rear derailleur.

Clear

Reset the traveling distance to default.

1. Press X1 or Y1 to select [DST].

SW-E8000-L/SC-E8000

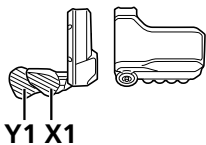

SW-E6000/SC-E6010

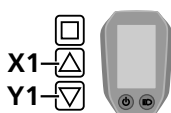

SC-E8000/SC-E6010

Configurable items	Details
Exit	Return to the menu list screen
DST	Clearing the traveling distance

SC-E6010

Default value set in the SC display setting

Configurable items	Default value
Backlight	ON
Beep	ON
Unit	km
Language	English
Brightness	3
Font color	White

SC-E8000



SC-E6010



2. To reset traveling distance, select [OK] using X1 or Y1 and press A to confirm. After resetting, the screen will automatically return to the menu list screen.

- A reset confirmation screen is not displayed on SC-E6010.

SW-E8000-L/SC-E8000

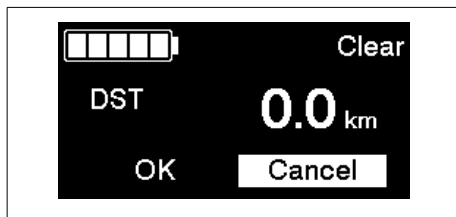
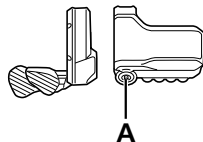

When the traveling distance is cleared, TIME, AVG and MAX are also cleared.

Clock

Configure the "Clock" setting.

1. Press X1 or Y1 to adjust the time.

- Press X1 to increase the numbers.
- Press Y1 to decrease the numbers.

SW-E8000-L/SC-E8000

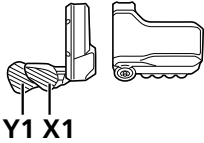

SW-E6000/SC-E6010

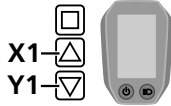

2. Pressing A enables the set value and moves you to the minutes setting.

SW-E8000-L/SC-E8000

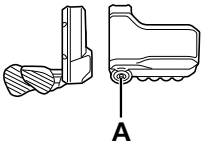

SW-E6000/SC-E6010

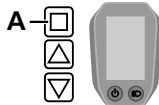

3. Press X1 or Y1 to set the minutes.

4. Press A to confirm the setting.

- After confirmation, the screen will automatically return to the menu list screen.



You can change the numbers quickly by holding down X1 or Y1.

Bluetooth LE (SC-E8000)

E-TUBE PROJECT for smartphones/tablets may be used if a Bluetooth LE connection is established with a smartphone/tablet.

1. Before setting up a connection, turn on Bluetooth LE on the smartphone/tablet.
2. Open E-TUBE PROJECT and set it to listen for Bluetooth LE signals.
3. Press X1 or Y1 to select [Start].
To start Bluetooth LE pairing, press A to confirm.
 - If you press A during Bluetooth LE pairing, the transmission will be interrupted, then the screen will return to the menu list screen.

SW-E8000-L/SC-E8000

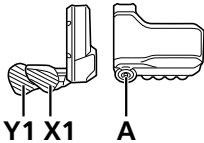

Configurable items	Details
Start	Starts Bluetooth LE pairing
Cancel	To not perform pairing, select [Cancel]

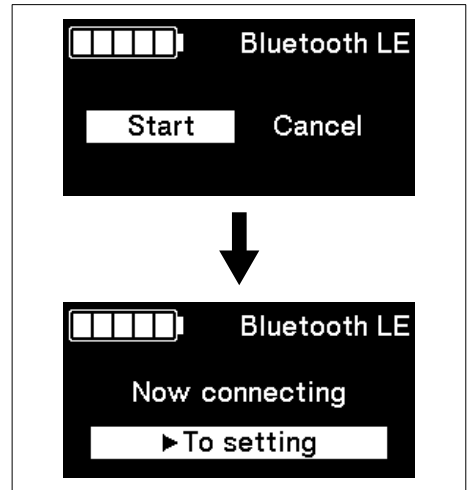

Generally, Bluetooth LE transmission will begin automatically when the cycle computer is turned on, however, pairing can be started by selecting [Start] from the [Bluetooth LE] menu when connectivity is poor.

- 4.** When connection is successful, SHIMANO STEPS logo is displayed on screen. If connection is not successful, a message indicating this is displayed.
- After successful connection or a connection failure, press one of X1/Y1/A or the screen will automatically return to the menu list screen after awhile.

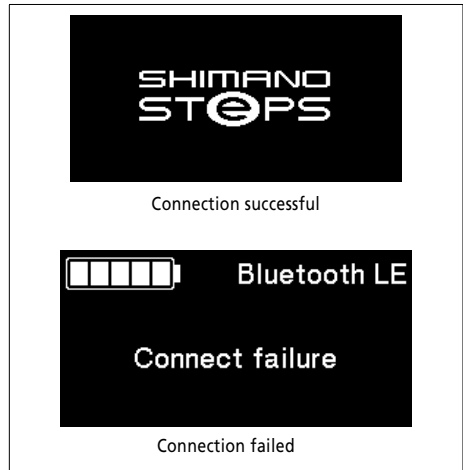

- 5.** When connection is successful, the unit name will display in E-TUBE PROJECT.

- 6.** Select the unit name displayed on screen.
- To disconnect, cancel the Bluetooth LE connection from the smartphone/tablet. (The cycle computer will exit connection mode and return to regular operation mode.)

Bluetooth LE/ANT (SC-E8000)

Current status of wireless connections can be displayed on screen.

For details on ANT connection, refer to "ANT connection" in the section "About wireless functions".

Select [Bluetooth LE/ANT] from the menu list screen and confirm to display current wireless connection status.

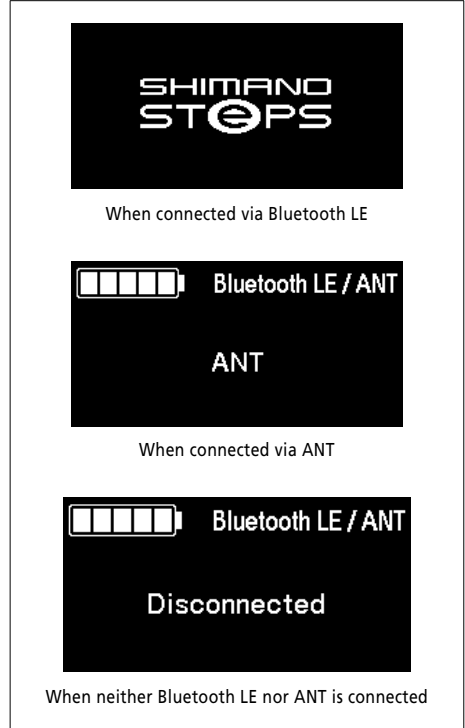

Light (SC-E8000)

Configure the battery-powered light setting.

1. Press X1 or Y1 to select the required setting.

SW-E8000-L/SC-E8000

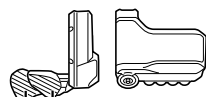

Y1 X1



Configurable items	Details
ON	Keep light always on
OFF	Keep light always off

2. Press A to confirm the setting.

- After confirmation, the screen will automatically return to the menu list screen.

SW-E8000-L/SC-E8000

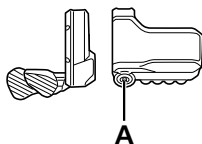

A

Turning the battery-powered light ON or OFF (SC-E6010)

When the battery-powered light is connected, push the light button on the cycle computer to turn the light on. An icon indicating that the light is on appears on the screen. Push the button again to turn the light off. Once the light is turned off, the icon on the screen disappears.

* When the battery powered light is not connected and [Backlight] is set to [MANUAL], pressing the light button turns the cycle computer's backlight on and off.

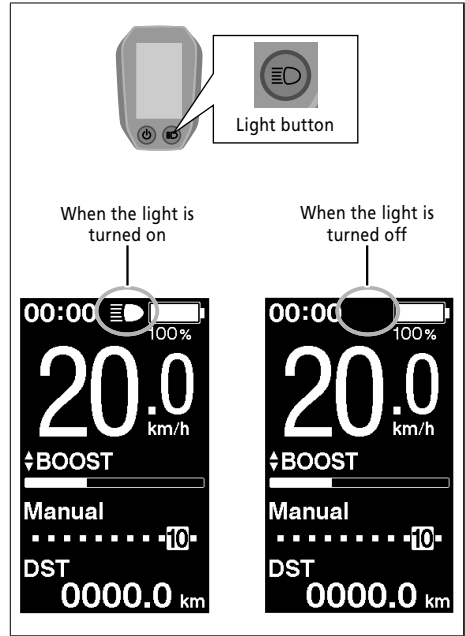

The light turns off in conjunction with the battery power.
When the battery power is off, the light is off.

Backlight (SC-E6010)

Configure the display backlight setting.

1. Press X1 or Y1 to select the required setting.

SW-E6000/SC-E6010

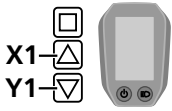

Configurable items	Details
ON	Keep light always on
OFF	Keep light always off
MANUAL	Turns on and off in conjunction with the battery-powered light

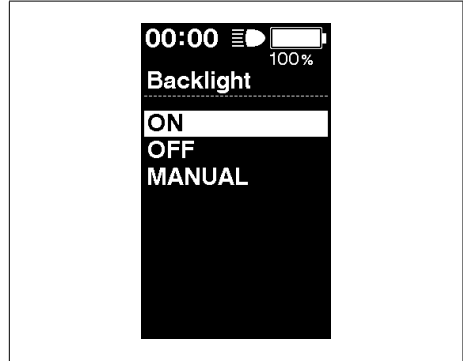

2. Press A to confirm the setting.

- After confirmation, the screen will automatically return to the menu list screen.

SW-E6000/SC-E6010

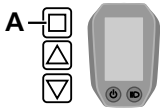

Brightness

The brightness of the backlight can be adjusted as needed.

1. Press X1 or Y1 to adjust the brightness.

- The brightness can be adjusted in 5 levels.

SW-E8000-L/SC-E8000

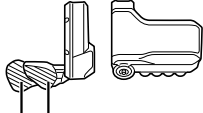

Y1 X1

SW-E6000/SC-E6010

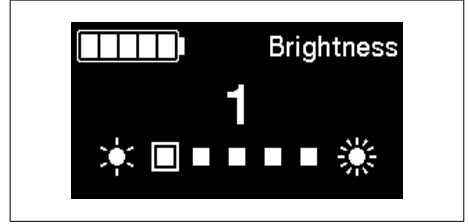
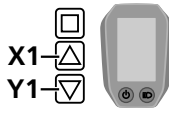

2. Press A to confirm the adjusted value.

- After confirmation, the screen will automatically return to the menu list screen.

SW-E8000-L/SC-E8000

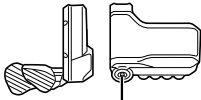

A

SW-E6000/SC-E6010

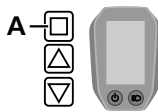

Beep

The beep noise can be turned on/off.

1. Press X1 or Y1 to select the required setting.

SW-E8000-L/SC-E8000

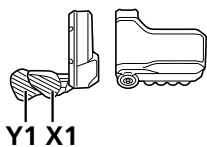

SW-E6000/SC-E6010

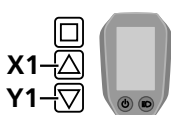

Configurable items	Details
ON	Enable beeps
OFF	Disable beeps

2. Press A to confirm the setting.

- After confirmation, the screen will automatically return to the menu list screen.

SW-E8000-L/SC-E8000

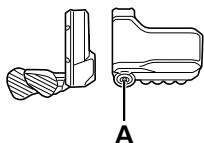

SW-E6000/SC-E6010

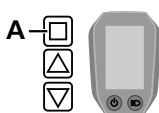

Even when [Beep] is set to OFF, a beep will sound when there is a misoperation, system error, etc.

Unit

Distance units (km/miles) can be switched.

1. Press X1 or Y1 to select the required setting.

SW-E8000-L/SC-E8000

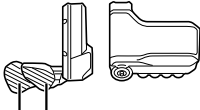

Y1 X1

SW-E6000/SC-E6010

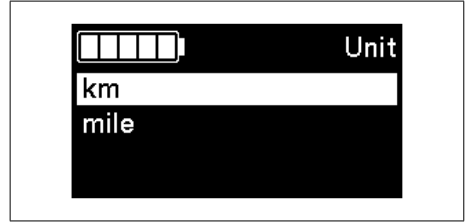
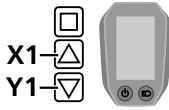

Configurable items	Details
km	Displayed in km
mile	Displayed in miles

2. Press A to confirm the setting.

- After confirmation, the screen will automatically return to the menu list screen.

SW-E8000-L/SC-E8000

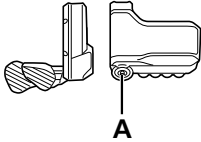

A

SW-E6000/SC-E6010

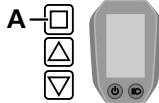

Language

Configure the language setting.

1. Press X1 or Y1 to select the required setting.

SW-E8000-L/SC-E8000

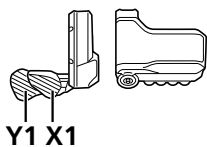

SW-E6000/SC-E6010

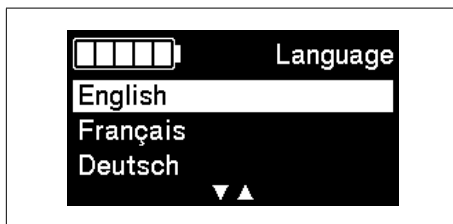
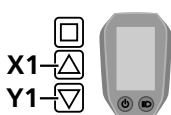

Language
English
French
German
Dutch
Italian
Spanish

2. Press A to confirm the setting.

- After confirmation, the screen will automatically return to the menu list screen.

SW-E8000-L/SC-E8000

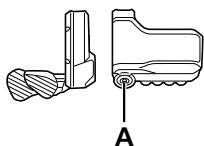

SW-E6000/SC-E6010

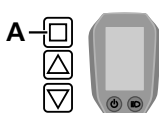

Font color (SC-E6010)

The font color can be changed.

1. Press X1 or Y1 to select the required setting.

SW-E6000/SC-E6010

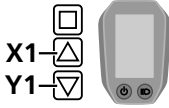

Configurable items
White
Black

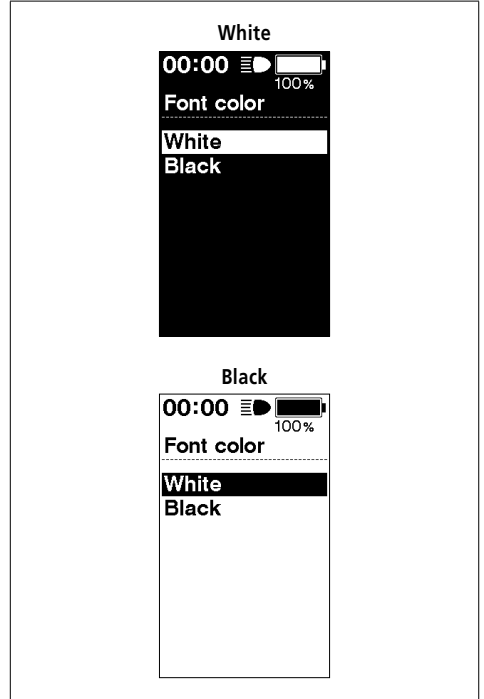

2. Press A to confirm the setting.
 - After confirmation, the screen will automatically return to the menu list screen.

SW-E6000/SC-E6010

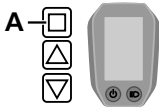

Adjust

You can adjust gear shifting only when using an electronic gear shifting unit.

If you need to adjust the derailleur, contact the place of purchase.

RD protection reset

In order to protect the system from falls etc., if the bicycle is subjected to a strong impact, the RD Protection function will operate and the connection between the motor and the link will be momentarily severed so that the rear derailleur can no longer operate. Executing RD Protection Reset restores the connection between the motor and the link, as well as the function of the rear derailleur.

1. Press X1 or Y1 to select [OK].

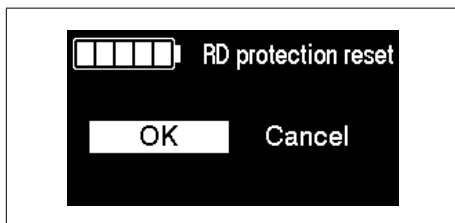
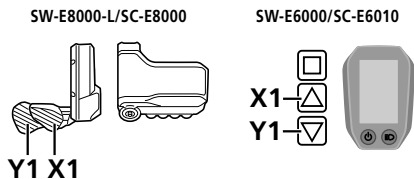

Configurable items	Details
OK	RD Protection Reset will operate
Cancel	To not execute RD Protection Reset, select [Cancel]

2. Press A to confirm [OK], recover the connection between the motor and the link by rotating the crank.

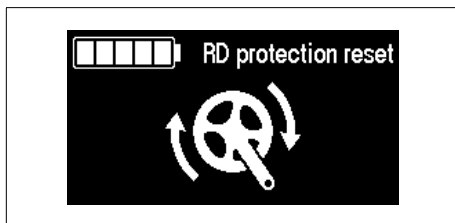
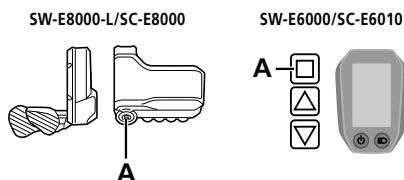

Exit

Closes the menu list screen and returns to the basic screen.

1. Press X1 or Y1 to select [Exit] on the menu list screen.
2. Press A to confirm. After confirmation, the screen will return to the basic screen.

Drive unit setting data backup function

The data saved to the drive unit is usually backed up automatically. However, performing the following operations will cause a message to appear asking whether or not to update the backup data.

- Reinstalling the cycle computer on a bicycle with different settings.
- Changing the drive unit settings via E-TUBE PROJECT.

Connection and communication with devices

The system can be configured and firmware can be updated when the bicycle is connected to a device.

You need E-TUBE PROJECT to configure SHIMANO STEPS and update firmware.

Download E-TUBE PROJECT from the support website (<http://e-tubeproject.shimano.com>).

For information on how to install E-TUBE PROJECT, check the support website.

NOTE

Connecting to devices is not possible while charging.



- You need SM-PCE1 and SM-JC40 / JC41 to connect SHIMANO STEPS to a PC.
 - Firmware is subject to change without notice.
- If necessary, contact the place of purchase.

■ About wireless functions

Functions

ANT connection

The wireless unit transmits the following information to the cycle computer.

- Battery level
- Front and rear derailleur gear positions
- Adjustment value



The latest functions can be checked by updating the software via E-TUBE PROJECT. For details, consult the place of purchase.

Bluetooth® LE connection

E-TUBE PROJECT for smartphones/tablets may be used if a Bluetooth LE connection is established with a smartphone/tablet.

How to make connections

ANT connection

ANT transmission will begin automatically when the cycle computer is turned on. To confirm whether connection was successful, check the [Bluetooth LE/ANT] menu.

Bluetooth® LE connection

Generally, Bluetooth LE transmission will begin automatically when the cycle computer is turned on, however, pairing can be started by [Bluetooth LE] menu when connectivity is poor.

2.4GHz digital wireless system





2.4GHz-frequency digital wireless technology, which is the same technology used for wireless LAN.



However, on very rare occasions, objects and places may generate strong electromagnetic, waves and interference, which may result in incorrect measurement.

- Television, PC, radios, motors/engines, or in car and trains.
- Railroad crossings and near railway tracks, around television transmitting stations and radar bases.
- Other wireless computers or digitally controlled light.

■ Battery LED lamp error indications

System errors and similar warnings are indicated by the battery LED lamps through various lighting patterns.

Error indication type	Indication condition	Lighting pattern *1	Recovery
System error	Communication error with the bicycle system		Make sure that the cable is not loose or improperly connected. If the situation does not improve, contact the place of purchase.
Temperature protection	If the temperature exceeds the guaranteed operating range, the battery output is turned off.		Leave the battery in a cool place away from direct sunlight until the internal temperature of the battery decreases sufficiently. If the situation does not improve, contact the place of purchase.
Security authentication error	This is displayed if a genuine drive unit is not connected. This is displayed if any of the cables are disconnected.		Connect a genuine battery and drive unit. Check the condition of the cables. If the situation does not improve, contact the place of purchase.
Charging error	This is displayed if an error occurs during charging.		Remove the charger from the battery and press the power button. If an error appears contact an agency.
Battery malfunction	Electrical failure inside the battery		Connect the charger to the battery and then remove the charger. Press the power button with only the battery connected. If an error appears with only the battery connected, contact the place of purchase.

*1  : No light  : Lighting up  : Blinking

■ Error messages on the cycle computer

Warnings

This disappears if the error is fixed.

SC-E8000



SC-E6010

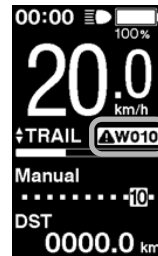

List of warnings

Code	Display preconditions	Operational restrictions while warning is displayed	Remedy
W010	Temperature of the drive unit is higher than it is during times of normal operation.	Power assistance may be lower than usual.	Stop using the assist function until the temperature of the drive unit drops. If the situation does not improve, contact the place of purchase.
W011	The traveling speed cannot be detected.	The maximum speed up to which power assistance is provided may be lower than usual.	Check that the speed sensor is properly installed. If the situation does not improve, contact the place of purchase.
W013	Initialization of torque sensor was not completed successfully.	Power assistance may be lower than usual.	With your foot off the pedal, press the battery power button and turn on the power again. If the situation does not improve, contact the place of purchase.
W032	An electronic derailleur may have been installed in place of a mechanical derailleur.	Power assistance provided in [WALK] mode may be lower than usual.	Reinstall the derailleur for which the system is configured to support. If the situation does not improve, contact the place of purchase.

Errors

If an error message is displayed on the entire screen, follow one of the procedures below to reset the display.

- Press the power button of the battery.
- Remove the battery from the holder.



If resetting the battery power does not solve the problem or the same problem occurs frequently, contact the place of purchase.



List of errors

Code	Display preconditions	Operational restriction when an error is being displayed	Remedy
E010	A system error was detected.	Power assistance is not provided during riding.	Press the power button of the battery to turn it on again. If the situation does not improve, contact the place of purchase.
E011	An error occurred in system operation.	Power assistance is not provided during riding.	Turn on the power again.
E013	An anomaly was detected in the drive unit's firmware.	Power assistance is not provided during riding.	Contact the place of purchase or bicycle dealer.
E014	The speed sensor may have been installed in the wrong position.	Power assistance is not provided during riding.	Contact the place of purchase or bicycle dealer.
E020	A communication error between the battery and drive unit was detected.	Power assistance is not provided during riding.	Check that the cable between the drive unit and battery is properly connected. If the situation does not improve, contact the place of purchase.
E021	Battery connected to drive unit conforms with system standards but is not supported.	Power assistance is not provided during riding.	Press the power button of the battery to turn it on again. If the situation does not improve, contact the place of purchase.
E022	Battery connected to drive unit does not conform with system standards.	All system functions shutdown.	Press the power button of the battery to turn it on again. If the situation does not improve, contact the place of purchase.

Code	Display preconditions	Operational restriction when an error is being displayed	Remedy
E043	Part of the cycle computer's firmware may be damaged.	Power assistance is not provided during riding.	Contact the place of purchase or bicycle dealer.

■ Troubleshooting

Assist function

Symptom	Cause / Possibility	Remedy
Assistance is not being provided.	Is the battery sufficiently charged?	Check the battery charge. If the battery is nearly spent, recharge it.
	Are you riding on long slopes in summer weather or riding for a long time carrying a heavy load? The battery may be overheating.	Turn off the power, wait for a while and then check once more.
	The drive unit (DU-E8000), cycle computer (SC-E8000 / SC-E6010) or assist switch (SC-E8000-L/SW-E6000) may be connected incorrectly or there may be a problem with one or more of them.	Contact the place of purchase.
	Is the speed too high?	Check the cycle computer display. Assistance is not provided at speeds of 25 km/h or more.
Assistance is not being provided.	Are you pedaling?	The bicycle is not a motorbike, so you need to operate the pedals.
	Is the assist mode set to [OFF]?	Set assist mode to a mode other than [OFF]. If you still do not feel that assistance is being given, contact the place of purchase.
	Is the system power ON?	If you have performed the steps below and still do not feel the assistance, contact the place of purchase. SC-E8000 Press the battery power button to turn the power ON. SC-E6010 Press and hold the cycle computer power button for 2 seconds, or press the battery power button to turn the power ON.

Symptom	Cause / Possibility	Remedy
Assist traveling distance is too short.	The traveling distance may become shorter depending on road conditions, the gear position and total light usage time.	Check the battery charge. If the battery is nearly spent, recharge it.
	The battery characteristics will drop during winter weather.	This is not a sign of a problem.
	The battery is a consumable part. Repeated recharging and long periods of use will cause the battery to deteriorate (lose its performance).	If the distance that can be traveled on a single charge is very short, replace the battery with a new one.
	Is the battery fully charged?	If the distance that can be traveled when the battery is fully charged has decreased, the battery may have degraded. Replace the battery with a new one.
Pedaling is stiff.	Are the tires inflated to a sufficient pressure?	Use a pump to add air.
	Is the assist mode set to OFF?	Set the assist mode to [BOOST]. If you still do not feel that assistance is being given, contact the place of purchase.
	The battery may be running low.	After charging the battery well, check the level of assistance again. If you still do not feel that assistance is being given, contact the place of purchase.
	Did you turn on the power with your foot placed on the pedal?	Turn on the power again without putting pressure on the pedal. If you still do not feel that assistance is being given, contact the place of purchase.

Battery

Symptom	Cause / Possibility	Remedy
The battery quickly loses its charge.	The battery may be at the end of its service life.	Replace the battery with a new one.
The battery cannot be recharged.	Is the power plug of the charger securely inserted into the electrical outlet?	Disconnect and then reconnect the power plug of the charger, and then repeat the recharging operation. If the battery still cannot be recharged, contact the place of purchase.
	Is the charging plug of the charger securely inserted into the battery?	Disconnect and then reconnect the charging plug of the charger, and then repeat the recharging operation. If the battery still cannot be recharged, contact the place of purchase.
	Is the charging adapter securely connected to the charging plug, or to the battery charging port?	Securely connect the charging adapter to the charging plug or to the battery charging port, and charge again. If the battery still does not charge, consult a dealer.
	Is the connecting terminal for the battery charger, charging adapter, or battery dirty?	Wipe the connection terminals with a dry cloth to clean them, and then repeat the recharging operation. If the battery still cannot be recharged, contact the place of purchase.
The battery does not start recharging when the charger is connected.	The battery may be at the end of its service life.	Replace the battery with a new one.
The battery and charger are becoming hot.	The temperature of the battery or charger may have exceeded the operating temperature range.	Stop recharging, wait for a while and then recharge again. If the battery is too hot to touch, it may indicate a problem with the battery. Contact the place of purchase.
The charger is warm.	If the charger is being used continuously to charge batteries, it may become warm.	Wait a while before using the charger again.
The LED on the charger does not illuminate.	Is the charging plug of the charger securely inserted into the battery?	Check the connection for any foreign objects before reinserting the charging plug. If there is no change, contact the place of purchase.
	Is the battery fully charged?	If the battery is fully charged, the LED on the battery charger turns off, but this is not a malfunction. Disconnect and then reconnect the power plug of the charger, and then repeat the recharging operation. If the LED on the charger still does not illuminate, contact the place of purchase.

Symptom	Cause / Possibility	Remedy
The battery cannot be removed.		Contact the place of purchase.
The battery cannot be inserted.		Contact the place of purchase.
Fluid is coming out from the battery.		Contact the place of purchase.
An abnormal odor can be detected.		Stop using the battery immediately and contact the place of purchase.
Smoke is coming out from the battery.		Stop using the battery immediately and contact the place of purchase.

Lights

Symptom	Cause / Possibility	Remedy
The front light or the tail light does not illuminate even when the switch is pressed.	The E-TUBE PROJECT settings may be wrong.	Contact the place of purchase.

Cycle computer

Symptom	Cause / Possibility	Remedy
The cycle computer is not displayed when you push the battery power button.	The amount of battery charge may be insufficient.	Recharge the battery, and then turn the power on once more.
	Is the power turned on?	Hold down the power button to turn on the power.
	Is the battery charging?	The power cannot be turned on while the battery is mounted on the bicycle and being charged. Stop charging.
	SC-E6010 Is the cycle computer correctly installed to the bracket?	Install the cycle computer correctly while referring to "Installing and removing the cycle computer".
	Is the electric wire connector correctly installed?	Check to see if the connector of the electric wire connecting the motor unit to drive unit is not disconnected. If you are not sure, contact the place of purchase.
	A component that the system cannot identify may be connected.	Contact the place of purchase.
SC-E6010 The system does not start up when you press and hold the cycle computer power button for 2 seconds.	Did you use the cycle computer in, or expose it to, low temperatures for an extended period?	The cycle computer may become unable to turn on if used in, or exposed to, low temperatures for an extended period. Turn it on by pressing the power button on the battery. If it still does not turn on, consult a dealer.
	Is the cycle computer correctly installed to the bracket?	Install the cycle computer correctly while referring to "Installing and removing the cycle computer".

Symptom	Cause / Possibility	Remedy
The gear position is not displayed.	The gear position is only displayed when using the electronic gear shifting unit.	Check if the electric wire connector is disconnected. If you are not sure, contact the place of purchase.
Can the beep be turned off.		Change the setting. Refer to "Beep".
SC-E6010 Can the backlight be turned off.		Change the setting. Refer to "Backlight".
The setting menu cannot be launched while riding the bicycle.	The product is designed so that if it detects that the bicycle is being ridden, the setting menu cannot be launched. This is not a sign of an abnormality.	Stop the bicycle and then make the settings.

Other

Symptom	Cause / Possibility	Remedy
When pressing the switch, two beeps sound, and the switch cannot be operated.	Operation of the switch being pressed has been disabled.	It is not a sign of a malfunction.
Three beeps sound.	An error or warning is occurring.	This occurs when a warning or error is displayed on the cycle computer. Refer to the section "Error messages on the cycle computer" and follow the instructions provided for the appropriate code.
When using an electronic gear shifting, I feel that the level of assistance weakens when the gears shift.	This occurs because the level of assistance is being adjusted to the optimum level by computer.	It is not a sign of a malfunction.
Sound occurs after gear shifting.		Contact the place of purchase.
A noise can be heard from the rear wheel during normal riding.	Gear shifting adjustment may not have been carried out correctly.	For mechanical gear shifting Adjust the cable tension. For details, refer to the Service Instructions for the derailleur. For electronic gear shifting Contact the place of purchase.
When you stop the bicycle, the gear does not shift to the position preset in the start mode.	You may have been pressing the pedals too strongly.	If you press the pedals lightly, the gear shifts more easily.

*** Key number**

The number that is on the key is required should you need to purchase spare keys.
Enter the key number in the box below and keep in a safe place.

Key number

SHIMANO

SHIMANO AMERICAN CORPORATION

One Holland, Irvine, California 92618, U.S.A. Phone: +1-949-951-5003

SHIMANO EUROPE B.V.

Industrieweg 24, 8071 CT Nunspeet, The Netherlands Phone: +31-341-272222

SHIMANO INC.

3-77 Oimatsu-cho, Sakai-ku, Sakai-shi, Osaka 590-8577, Japan

Please note: specifications are subject to change for improvement without notice. (English)

© Sep. 2016 by Shimano Inc. HTR